

INTRODUCTION



Mechanical vibration and shock are present in varying degrees in virtually all locations where equipment and people function. The adverse effect of these disturbances can range from negligible to catastrophic depending on the severity of the disturbance and the sensitivity of the equipment.

In one extreme, the vibration environment may consist of low-level seismic disturbances present everywhere on earth, which present operating problems to highly sensitive items such as delicate optical equipment. When other disturbances are superimposed on the seismic disturbances, a wide range of precision equipment is adversely affected.

These other disturbances are caused by such things as vehicular and foot traffic, passing trains, air conditioning systems, and nearby rotating and reciprocating machinery. They cause resolution problems in electron microscopes, disturb other optical systems, cause surface finish problems on precision grinders and jig borers, and hamper delicate work on microcircuitry.

Another concept is the detrimental effect of vibrating internal components of certain equipment such as motors, blowers, and fans in computers or similar systems. These components transmit noise and vibration to the surrounding structure resulting in fatigue, reduced reliability, and a “noisy” product.

When compared to stationary applications, vehicular installations subject equipment to much more severe shock and vibration. Vibration from a propulsion engine is present in air, sea and road vehicles as well as shock and vibration effects from the media in which they travel.

Such common phenomena as air turbulence and rough roads impart severe dynamic transients to the vehicles traveling on them. In addition to rough seas, military ships are also subjected to very severe mechanical shock when they encounter near-miss air and underwater explosions in combat.

Vibration-control techniques in the form of shock and vibration isolators have been devised to provide dynamic protection to all types of equipment.

In discussing vibration protection, it is useful to identify the three basic elements of dynamic systems:

1. The equipment (component, machine motor, instrument, part, etc. ..);
2. The support structure (floor, baseplate, concrete foundation, etc. ..); and
3. The resilient member referred to as an isolator or mount (rubber pad, air column, spring, etc.) which is interposed between the equipment and the support structure.

If the equipment is the source of the vibration and/or shock, the purpose of the isolator is to reduce the force transmitted from the equipment to the support structure. The direction of force transmission is from the equipment to the support structure. This is illustrated in Figure 1, where M represents the mass of a motor which is the vibrating source, and K , which is located between the motor and the support structure, represents the isolator.

If the support structure is the source of the vibration and/or shock, the purpose of the isolator is to reduce the dynamic disturbance transmitted from the support structure to the equipment. The direction of motion transmission is from the support structure to the equipment. This occurs, for instance, in protecting delicate measuring instruments from vibrating floors. This condition is illustrated in Figure 2, where M represents the mass of a delicate measuring instrument which is protected from vibrating floor by an isolator signified as K .

In either case, the principle of isolation is the same. The isolator, being a resilient element, stores the incoming energy at a time interval which affords a reduction of the disturbance to the equipment or support structure.

The purpose of this Design Guide is to aid the design engineer in selecting the proper isolator to reduce the amount of vibration and/or shock that is transmitted to or from equipment.

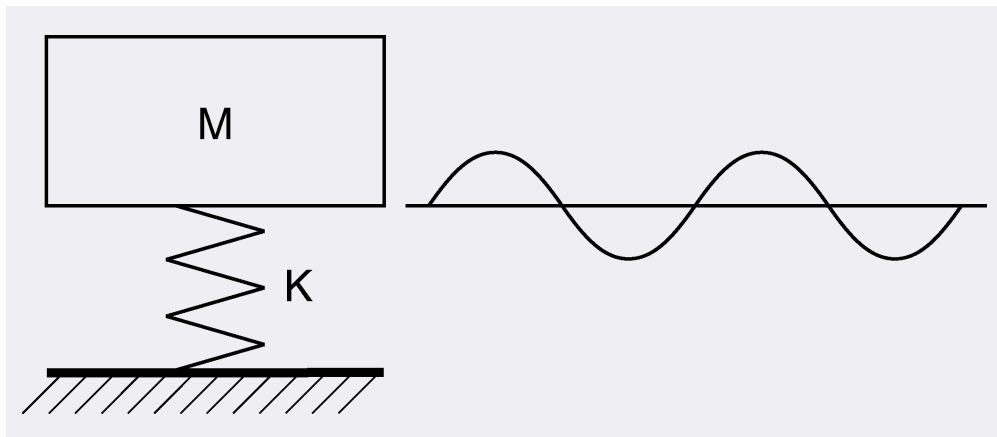

Figure 1 Schematic diagram of a dynamic system where the mass, M, is the vibratory source

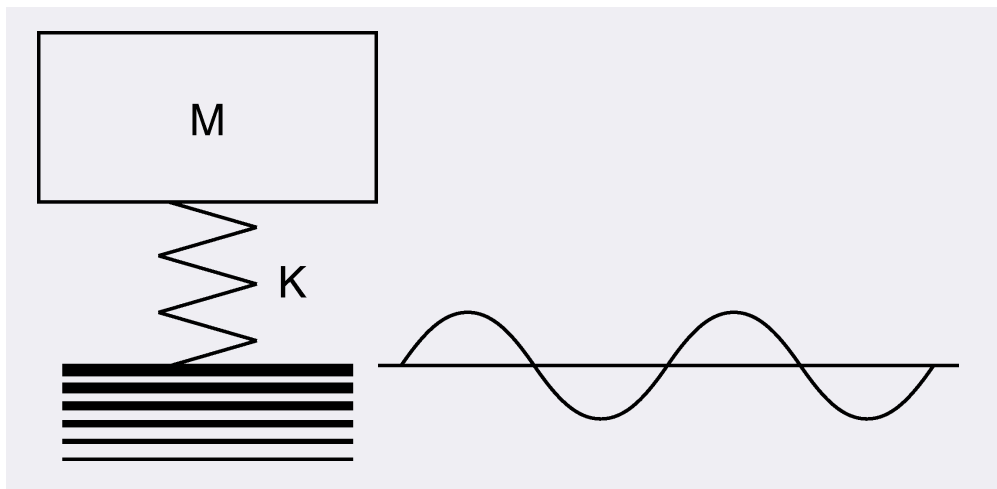

Figure 2 Schematic diagram of a dynamic system where floor is the vibratory source

DEFINITIONS

Although a vibration isolator will provide some degree of shock isolation, and vice versa, the principles of isolation are different, and shock and vibration requirements should be analyzed separately. In practical situations, the most potentially troublesome environment, whether it be vibration or shock, generally dictates the design of the isolator. In other applications, where both are potentially troublesome, a compromise solution is possible.

Before a selection of a vibration and/or shock isolator can be made, the engineer should have a basic understanding of the following definitions, symbols, and terms:

Vibration: A magnitude (force, displacement, or acceleration) which oscillates about some specified reference where the magnitude of the force, displacement, or acceleration is alternately smaller and greater than the reference. Vibration is commonly expressed in terms of frequency (cycles per second or Hz) and amplitude, which is the magnitude of the force,

displacement, or acceleration. The relationship of these terms is illustrated in Figure 3.

Frequency: Frequency may be defined as the number of complete cycles of oscillations which occur per unit of time.

$$\text{Frequency} = f = \frac{\text{cycles}}{\text{second}} (\text{cps}) = \text{Hertz (Hz)}$$

Period: The time required to complete one cycle of vibration.

$$\text{Period} = \lambda = \frac{1}{f}$$

Forcing Frequency: Defined as the number of oscillations per unit time of an external force or displacement applied to a system.

$$\text{Forcing Frequency} = f_d$$

Natural Frequency: Natural frequency may be defined as the number of oscillations that a system will carry out in unit time if displaced from its equilibrium position and allowed to vibrate freely. (See Figure 3)

Eq. 1
$$f_n = \frac{1}{2\pi} \sqrt{\frac{K}{M}}$$

Eq. 2
$$f_n = \frac{1}{2\pi} \sqrt{\frac{Kg}{W}}$$

Eq. 3
$$f_n = 3.13 \sqrt{\frac{K}{W}}$$

Natural frequency in terms of static deflection:

Eq. 4
$$f_n = 3.13 \sqrt{\frac{1}{\Delta_s}}$$

Also, natural frequency for torsional vibration:

Eq. 5
$$f_n = 3.13 \sqrt{\frac{K_t}{I}}$$

Equations 1 through 5 all neglect the effects of damping. When damping is considered, Equation 2 becomes:

Eq. 6
$$f_n = \frac{1}{2\pi} \sqrt{\frac{Kg}{W} \left[1 - \left(\frac{C}{C_c} \right)^2 \right]}$$

Amplitude: The amplitude of a harmonic vibration such as displacement, velocity, or acceleration is the zero to peak value corresponding to the maximum magnitude of a harmonic vibration time-history. (See Figure 3.)

Displacement: Displacement is a vector quantity that specifies the change of the position of a body or particle and is usually measured from the mean position or equilibrium position. In general it can be represented by a translation or rotation vector or both. (See Figure 3)

$$\text{Displacement} = X = \text{inches, feet, etc...}$$

Velocity: Velocity is a vector that specifies the time rate change of displacement with respect to a frame of reference.

$$\text{Velocity} = V = \dot{X} = \frac{\text{inches}}{\text{sec}}$$

Acceleration: Acceleration is a vector that specifies the time rate of change of velocity with respect to a frame of reference. The acceleration produced by the force of gravity, which varies with the latitude and elevation of the point of

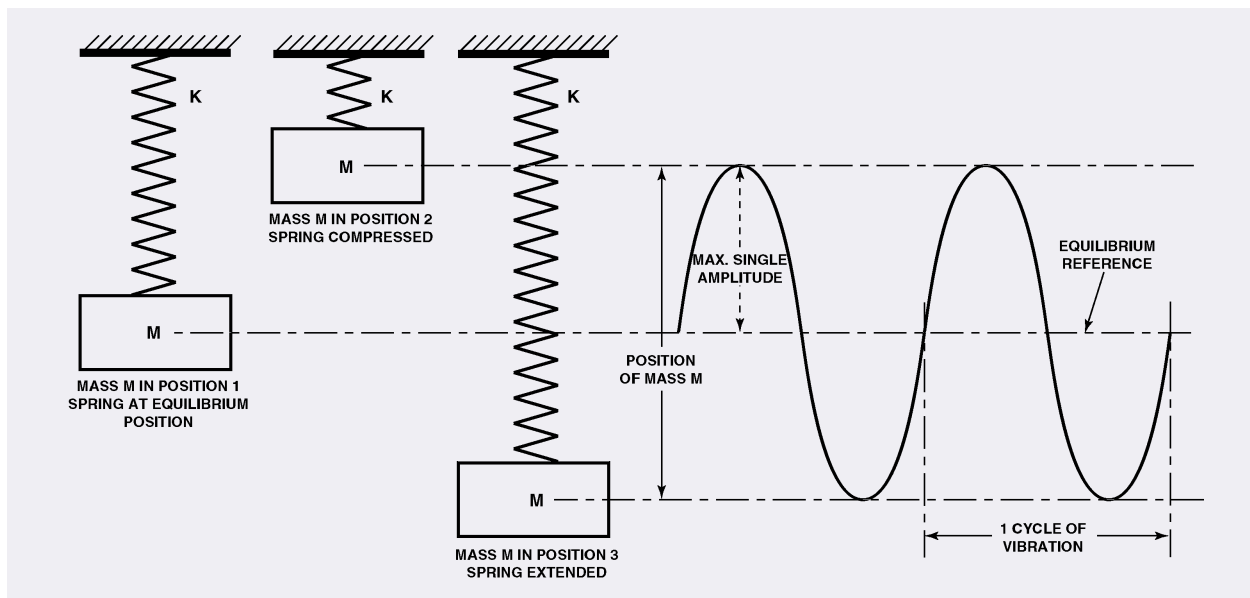

Figure 3 Schematic of oscillating spring mass system and graphical representation of vibratory responses

observation, is given by $g = 980.665$ centimeters per second = 386.093 in/sec = 32.1739 ft/sec, which has been chosen as a standard acceleration due to gravity.

$$\text{Acceleration} = g = \ddot{X} = \frac{\text{inches}}{\text{sec}^2}$$

Deflection: Deflection is defined as the distance an body or spring will move when subjected to a static or dynamic force, F.

$$\text{Deflection} = \Delta = \text{inches}$$

Spring Stiffness: Described as a constant which is the ratio of a force increment to a corresponding deflection increment of the spring.

Eq. 7

$$\begin{aligned} \text{Spring Stiffness} = K &= \frac{F}{\Delta} \\ &= \frac{\text{Force}}{\text{Deflection}} = \frac{\text{lb}}{\text{in}} \end{aligned}$$

Rotational spring stiffness:

Eq. 8

$$\begin{aligned} K_r = \frac{m}{\phi} &= \frac{\text{Moment}}{\text{Angular Displacement}} \\ &= \frac{\text{in} \cdot \text{lb}}{\text{sec}} \end{aligned}$$

Elastic Center: The elastic center is defined as a single point at which the stiffness of an isolator or system isolators can be represented by a single stiffness value.

Damping: Damping is the phenomenon by which energy is dissipated in a vibratory system. Three types of damping generally encountered are: coulomb, hysteresis and viscous.

Coulomb Damping: If the damping force in a vibratory system is constant and independent of the position or velocity of the system, the system is said to have coulomb or dry friction damping.

Hysteresis (Inherent) Damping: Damping which results from the molecular structure of a material when that material is subjected to motion is referred to as hysteresis damping. Elastomers are good examples of materials which possess this type of damping.

Viscous Damping: If any particle in a vibrating body encounters a force which has a magnitude proportional to the magnitude of the velocity of the particle in a direction opposite to the direction of the velocity of the particle, the particle is said to be viscously damped. This is the easiest type of damping to model mathematically. All of the equations in this text are based on use of a viscous damping coefficient. Although most isolators do not use viscous

damping, equivalent viscous damping usually yields excellent results when modeling systems.

Damping Coefficient: Damping for a material is expressed by its damping coefficient.

$$\text{Damping coeff.} = C = \frac{\text{lb} \cdot \text{sec}}{\text{in}}$$

Critical Damping: A system is said to be critically damped when it is displaced from its static position and most quickly returns to this initial static position without any over-oscillation. The damping coefficient required for critical damping can be calculated using:

Eq. 9

$$C_c = 2\sqrt{KM}$$

Damping Factor: The non-dimensionless ratio which defines the amount of damping in a system.

$$\text{Damping factor} = \frac{C}{C_c} = \zeta$$

Resonance: When the forcing frequency coincides with the natural frequency of a suspension system, this condition is known as resonance.

Transmissibility: Defined as the ratio of the dynamic output to the dynamic input.

Eq. 10

$$T = \frac{\sqrt{1 + \left(2 \frac{f_d}{f_n} \cdot \frac{C}{C_c}\right)^2}}{\sqrt{\left(1 - \frac{f_d^2}{f_n^2}\right)^2 + \left(2 \frac{f_d}{f_n} \cdot \frac{C}{C_c}\right)^2}}$$

For negligible damping (), T becomes:

Eq. 11

$$T = \left| \frac{1}{1 - \left(\frac{f_d}{f_n}\right)^2} \right|$$

When resonance occurs, and, T is at its max and Equation 10 becomes:

Eq. 12

$$T_{\max} = \frac{1}{2 \frac{C}{C_c}}$$

Shock: Defined as a motion in which there is a sharp, nearly sudden change in velocity. Examples of this are a hammer blow on an anvil or a package falling to the ground. Shock may be expressed mathematically as a motion in which the velocity changes very suddenly.

Shock Pulse: Shock pulse is a primary disturbance characterized by a rise and decay of acceleration from a constant value in a very short period of time. Shock pulses are normally displayed graphically as acceleration vs. time curves. See Figure 11 for examples of typical curves.

Shock Transmission: Shock transmitted to the object subjected to the shock. This can be calculated with the following equation:

Eq. 13

$$\text{Shock transmitted} = G_T$$

$$G_T = \frac{V(2\pi f_n)}{386} = \frac{V(f_n)}{61.4}$$

In this equation, V represents an instantaneous velocity shock. Most shock inputs can be approximated by an instantaneous velocity shock. See shock isolation section starting on page X for more detail.

The associated dynamic linear deflection of an isolator under shock can be determined by the use of the following equation:

Eq. 14

$$\Delta_D = \frac{V}{2\pi f_n}$$

DESIGN CONSIDERATIONS

Vertical Vibration: In the general introduction of this Guide, it was pointed out that vibration and shock can have gross detrimental effects on the performance and reliability of a particular product. The vibration which a unit transmits to a supporting structure or the vibration which a unit feels when it is being excited by a vibrating structure can be reduced or attenuated by an isolator if properly selected. Referring to the following discussion of how an isolator functions, the design example section of this Guide contains problem solutions which use the equations and graphs presented in this section.

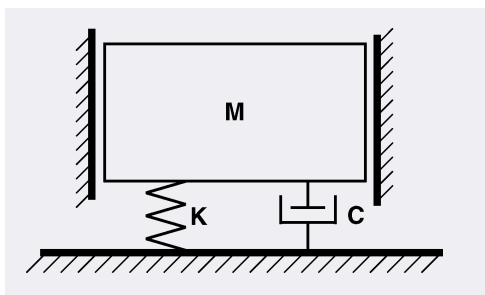

Figure 4 Schematic of the simplest form of an isolator, a spring, K, and a viscous damper, C, supporting the equipment mass, M.

The function of an isolator may be best understood by first reducing it to its simplest form, as illustrated in Figure 4. The system of Figure 4 includes a rigid mass M supported by a spring K and constrained by guides to move only in vertical translation without rotation about a vertical axis. A damper C is arranged in parallel with the spring between the support and the mass. The mounted equipment is simulated by the mass while the spring and damper taken together simulate the elasticity and damping of the conventional isolator. The system shown in Figure 4 is said to be a single-degree-of-freedom system because its configuration at any time may be specified by a single coordinate; e.g., by the height of the mass M with respect to the fixed support.

Isolation is attained primarily by maintaining the proper relationship between the disturbing frequency and the system's natural frequency. The characteristics of the isolator include its natural frequency, or more properly, the natural frequency of the system consisting of isolator and mounted equipment. In general, a system has a natural frequency for each degree of freedom; the single-degree-of-freedom system illustrated in Figure 4 thus has one natural frequency. The expression for the damped natural frequency of the system illustrated in Figure 4, expressed in cycles per second, is:

(Eq. 6)

$$f_n = \frac{1}{2\pi} \sqrt{\frac{Kg}{W} \left[1 - \left(\frac{C}{C_c} \right)^2 \right]}$$

A critically damped system returns without oscillation to equilibrium if displaced; it has no natural frequency of oscillation, as indicated by the substitution of $C=C_c$ in Equation 6.

In most circumstances the value of the damping coefficient is relatively small. The influence of damping on the natural frequency may then be neglected. Setting the damping coefficient C equal to zero, the system becomes an undamped single-degree-of-freedom system, and the undamped natural frequency given by:

(Eq. 2)

$$f_n = \frac{1}{2\pi} \sqrt{\frac{Kg}{W}}$$

This expression is sufficiently accurate for calculating the actual natural frequency in most instances.

The concept of static deflection often is used to define the characteristics of an isolator. Static deflection is the deflection of the isolator under the static or deadweight load of the mounted equipment. Referring to Equation 2 and substituting in/sec², the following expression is obtained for natural frequency in terms of static deflection:

(Eq. 4)

$$f_n = 3.13 \sqrt{\frac{1}{\Delta_s}}$$

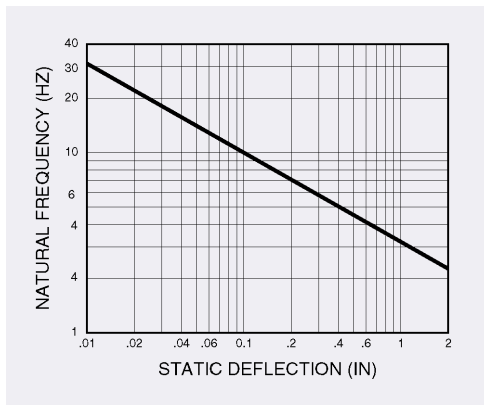

Figure 5 Relation of natural frequency and static deflection of a linear, single-degree-of-freedom system.

A graphic portrayal of Equation 4 is given in Figure 5. It thus appears possible to determine the natural frequency of a single-degree-of-freedom system by measuring only the static deflection. This is true with certain qualification. First, the spring must be linear — its force vs. deflection curve must be a straight line. Second, the resilient material must have the same type of elasticity under both static and dynamic conditions.

Metallic springs generally meet this latter requirement, but many organic materials used in isolators do not. The dynamic modulus of elasticity of these materials is higher than the static modulus; the natural frequency of the isolator is thus somewhat greater than that calculated on the basis of static deflection alone.

Dynamic stiffness may be obtained indirectly by determining the natural frequency when the isolator is vibrated with a known load and calculating the dynamic stiffness from Equation 2. The various organic materials have certain peculiarities with respect to dynamic stiffness which will be discussed later in connection with the specific materials.

Effectiveness of isolators in reducing vibration is indicated by the transmissibility of the system. Figure 6 illustrates a typical transmissibility curve for an equipment of weight W supported on an isolator with stiffness K and damping coefficient C which is subjected to a vibration disturbance of frequency f_d . When the system is excited at its natural frequency, the system will be in resonance and the disturbance forces will be amplified rather than reduced. Therefore, it is very desirable to select the proper isolator so that its natural frequency will be excited as little as possible in service and will not coincide with any critical frequencies of the equipment.

Referring to Figure 6, it can be seen that when the ratio of the disturbing frequency f_d over the natural frequency f_n is less than or 1.4, the transmissibility is greater than 1, or the equipment experiences amplification of the input. Simply expressed, when:

$$f_d / f_n \leq \sqrt{2}, T \geq 1$$

theoretically, isolation begins when:

$$f_d / f_n = \sqrt{2} \text{ (at this point } T = 1 \text{)}$$

Also it can be seen that when:

$$f_d / f_n > \sqrt{2}, T < 1$$

the mounted unit is said to be isolated; i.e., the output X_o is less than input X_i .

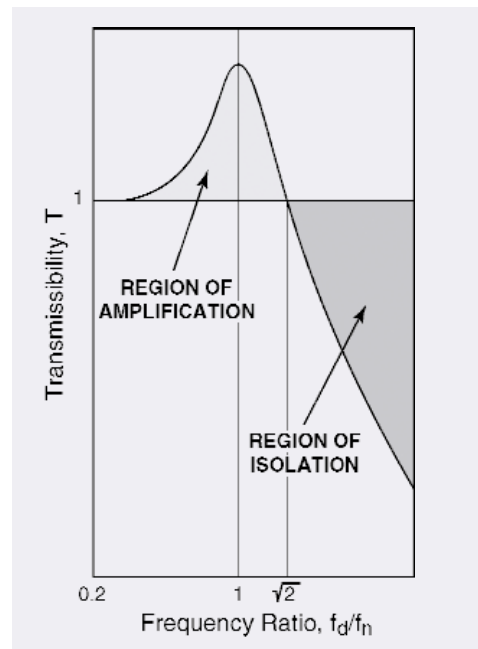

Figure 6 Typical transmissibility curve for an isolated system where f_d = disturbance frequency and f_n = isolation system natural frequency.

Damping: The majority of isolators possess damping in varying degrees. A convenient reference illustrating damping factor C/C_c for various materials is shown in Table 1. Damping is advantageous when the mounted system is operating at or near its natural frequency because it helps to reduce transmissibility. For example, consider an internal combustion engine mounted on steel springs which possess very little damping (see Table 1). Upon start up of the engine and as the engine RPM increases, the disturbing frequency of the engine will at some point correspond with the natural frequency of the spring-mass system. With light damping,

the buildup of forces from the engine to the support will be very large; that is, transmissibility will be very high. If the idle RPM of the engine falls in the range of the natural frequency of the spring-mass system, serious damage may result to the engine or to the support chassis. If, on the other hand, the designer selects an elastomeric isolator which possesses a higher degree of damping, amplification at resonance would be much less.

Material	Approx Damping Factor C/C_c	T_{max} (approx.)
Steel Spring	0.005	100
Elastomers:	-	-
Natural Rubber	0.05	10
Neoprene	0.05	10
Butyl	0.12	4.0
Barry Hi Damp	0.15	3.5
Barry LT	0.11	4.5
Barry Universal	0.08	6.0
Friction Damped Springs	0.33	1.5
Metal Mesh	0.12	4.0
Air Damping	0.17	3.0
Felt and Cork	0.06	8.0

Table 1 Damping factors for materials commonly used for isolators

The relationship between a highly damped and a lightly damped system is illustrated in Figure 8. This figure shows that as damping is increased, isolation efficiency is somewhat reduced in the isolation region. While high values of damping cause significant reduction of transmissibility at resonance, its effect in the isolation region is only a small increase transmissibility.

A family of curves which relate f_n , f_d , transmissibility and damping are shown in Figure 8. This family of curves was derived by use of Equation 10.

Horizontal Vibration: When an isolation system is excited horizontally, two natural frequencies result if the center of gravity of the unit is not in line with the elastic center of the isolators. A typical transmissibility curve illustrating this horizontal vibration output is illustrated in Figure 9. The two natural frequencies which are involved include a lower mode wherein the equipment rocks about a point well below the elastic center of the isolators and a higher mode where the equipment oscillates about a point in the vicinity of the center of gravity. Two other natural frequencies will occur if the equipment is rotated 90 degrees in the horizontal plane with respect to the exciting force.

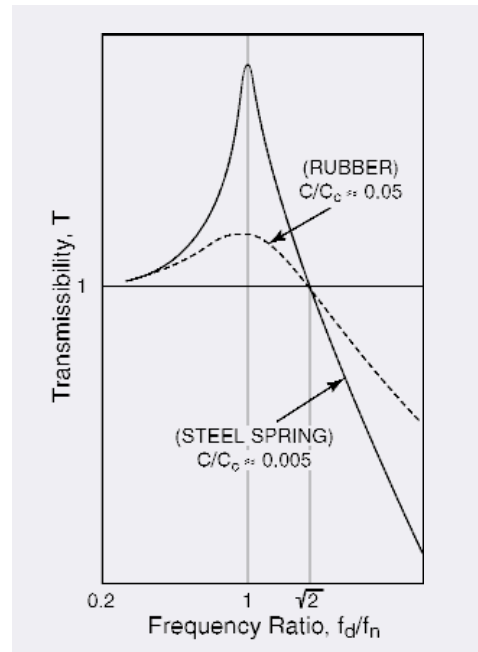

Figure 7 Typical transmissibility curves for highly and lightly damped systems.

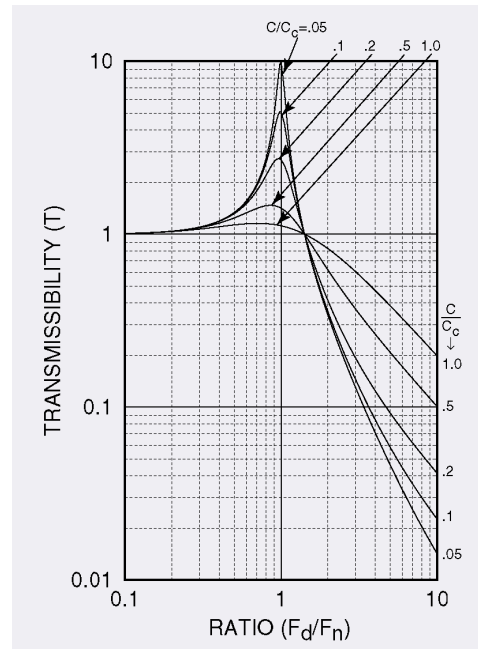

Figure 8 Family of transmissibility curves for a single degree of freedom system.

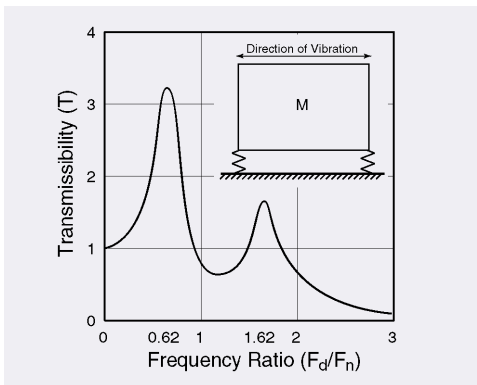

Figure 9 Typical transmissibility curve for horizontal vibration inputs.

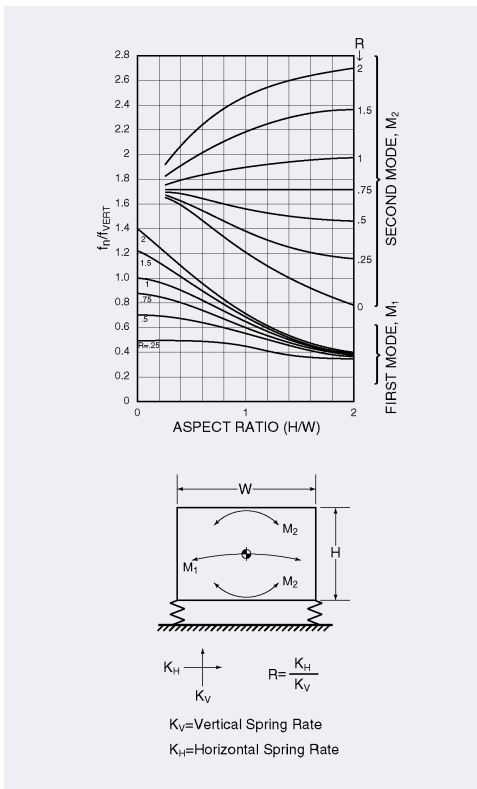

Figure 10 Horizontal natural frequencies of a homogeneous solid mounted on linear, undamped springs at edge of mass.

Figure 10 can be used to determine the approximate frequencies of these modes as a function of spring stiffness and equipment dimensions. These curves assume that the equipment is solid, of uniform mass, and that the isolators are attached at the extreme corners. Under horizontal excitation the equipment may be made to translate only by lining up the center of gravity of the equipment with the elastic center of the isolators instead of installing the isolators at the bottom corners of the equipment. In this case, Figure 10 may be applied by letting $H/W = 0$, which results in only one mode of vibration, that of translation. A second mode can only be excited by torsional excitation.

Structure-Borne Noise: The demand on equipment today is to maximize its output which generally requires faster operation and more complex mechanical motions. As a result, noise is sometimes generated. High frequency disturbances are excited because the moving components within the equipment impose vibratory inputs to the internal structures. These vibrations are amplified and structure-borne noise is encountered. Complete equipments bolted to their support foundations also cause similar noisy conditions.

An effective and low cost means of alleviating structure-borne noise problems is to physically separate the solid structures and interpose a resilient material between them. In this manner a mechanical attachment is provided but the resilient media prevents the vibration forces from being transmitted and structure-borne noise is substantially reduced.

Elastomeric materials are generally best suited for structure-borne noise reduction. They exhibit the desirable characteristics of shape flexibility and inherent damping to avoid spring-like response which might produce violent resonances at critical frequencies. They afford high frequency isolation. Many isolators suitable for attenuation of structure-borne noise problems are available from Barry and these are outlined in the Selection Guide, Section 6.

Shock: Shock is normally classified as a transient phenomenon, while a typical vibration input is classified as a steady-state phenomenon. A shock input pulse is normally described by its peak amplitude A expressed in g 's, by its duration t normally expressed in milliseconds, and its overall shape, which can take such forms as half-sine, triangular, (initial peak sawtooth, symmetrical and terminal peak sawtooth), versed sine, rectangular, and the form most likely to occur in nature, a more or less random shaped complex waveform force and acceleration impulse as shown in Figure 11.

Since there are many types of shock pulses encountered in nature, there are many types of shock tests specified for testing a piece of equipment. The different shock tests are normally associated with the environment that the equipment will encounter during its lifetime. Equipment installed in aircraft is normally tested on a free-fall shock machine which will generate either a half-sine or terminal peak sawtooth form. A typical test is an 11-millisecond half-sine waveform with a peak acceleration of 15 g 's. For components in some areas of missiles where large shock pulses will be felt due to explosive separation of stages, a 6-millisecond sawtooth at 100 g 's may be specified. If a piece of equipment is going on board a Navy vessel, the normal test will be the hammer blow specified in MIL-S-901, which exhibits a velocity shock of approximately 120 in./sec. Shipping containers are normally tested by dropping the container on a concrete floor, or by suspending it by some suitable support mechanism and letting it swing against a concrete abutment. Other tests pertaining to shipment are edge and corner drops from various drop heights. All of these tests

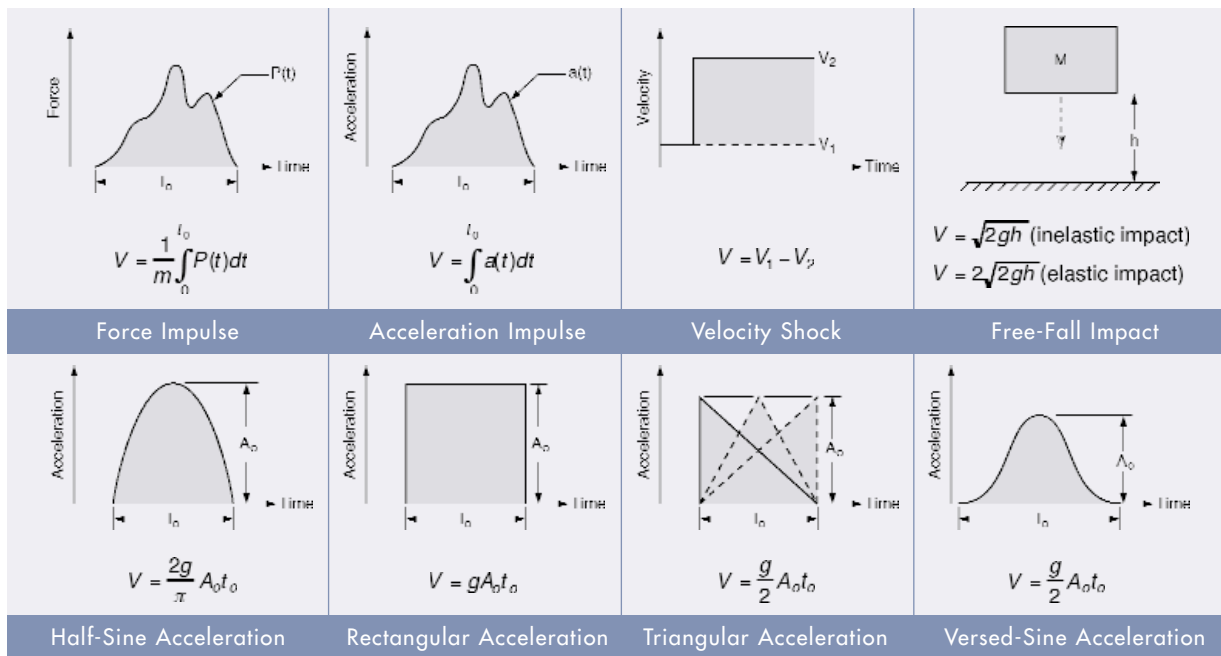

Figure 11 Idealized forms of shock excitation and the velocity change, V , associated with each shock pulse

mentioned attempt to simulate the shock pulse which will be encountered in the normal environment of the equipment. These are generally called out by the specific contractual requirements either in a specification or in a work requirement.

The isolation of shock inputs is considerably different from that of a vibration input. The shock isolator is characterized as a storage device wherein the input energy, usually with a very steep wave front, is instantaneously absorbed by the isolator. This energy is stored in the isolator and released at the natural frequency of the spring-mass system.

The most common procedure for predicting shock isolation is a mathematical approach utilizing equations in Figure 11, for determining the velocity, and Equation 13, for calculating transmitted accelerations.

Another means is through the use of shock transmissibility curves. Shock transmissibility curves are not included in this Guide, but are included in a technical paper published by Barry Controls titled Passive Shock Isolation. Please call 1-800-BARRY MA for a copy of this paper.

These two methods are valid for solving shock problems provided that the shock pulse is thoroughly defined, and that the isolation system responds in its linear region.

Nonlinear Isolators: The preceding discussion of vibration and shock isolation presumes that the isolator is linear, the force-deflection curve for the isolator is a straight line. This simplified analysis is entirely adequate for many purposes. In the isolation of steady-state vibration, displacement amplitude is usually small, and nonlinearity of the isolator tends to be unimportant except where deflection resulting from the static load is relatively great. In the

isolation of shock, nonlinearity tends to be more important because large deflections prevail. The degree of isolation may then be substantially affected by the ability, or lack thereof, of the isolator to accommodate the required deflection.

In many applications of shock isolation, sufficient space is not available to allow for full travel of a linear isolator. Therefore, a nonlinear isolator is necessary. There are two types of isolators that can be designed to help solve the problem of insufficient space.

The first solution is to make an isolator that gets stiffer as deflection increases. This will limit the amount of motion, but will increase the G level imparted on the equipment.

The second is to use an isolator that is stiff at small deflection, but gets softer at higher deflections. This is referred to as a buckling isolator, and is shown in Figure 12. This allows the isolator to store more energy in the same amount of deflection. (A shock isolator is basically an energy storage device; it stores high g-level, short-duration shock and releases them as low g-level, longer-duration shocks.)

ISOLATORS AND MATERIALS

Isolators are made from a wide variety of resilient media having diverse characteristics. Each type of isolator has characteristic properties and is particularly suited to certain specialized applications. To make the best use of available isolators, the designer should understand the basic properties of each type. He should also be familiar with the requirements for isolators for various types of equipment, as indicated in the preceding discussions. Keep in mind that not all isolators can be manufactured out of any material.

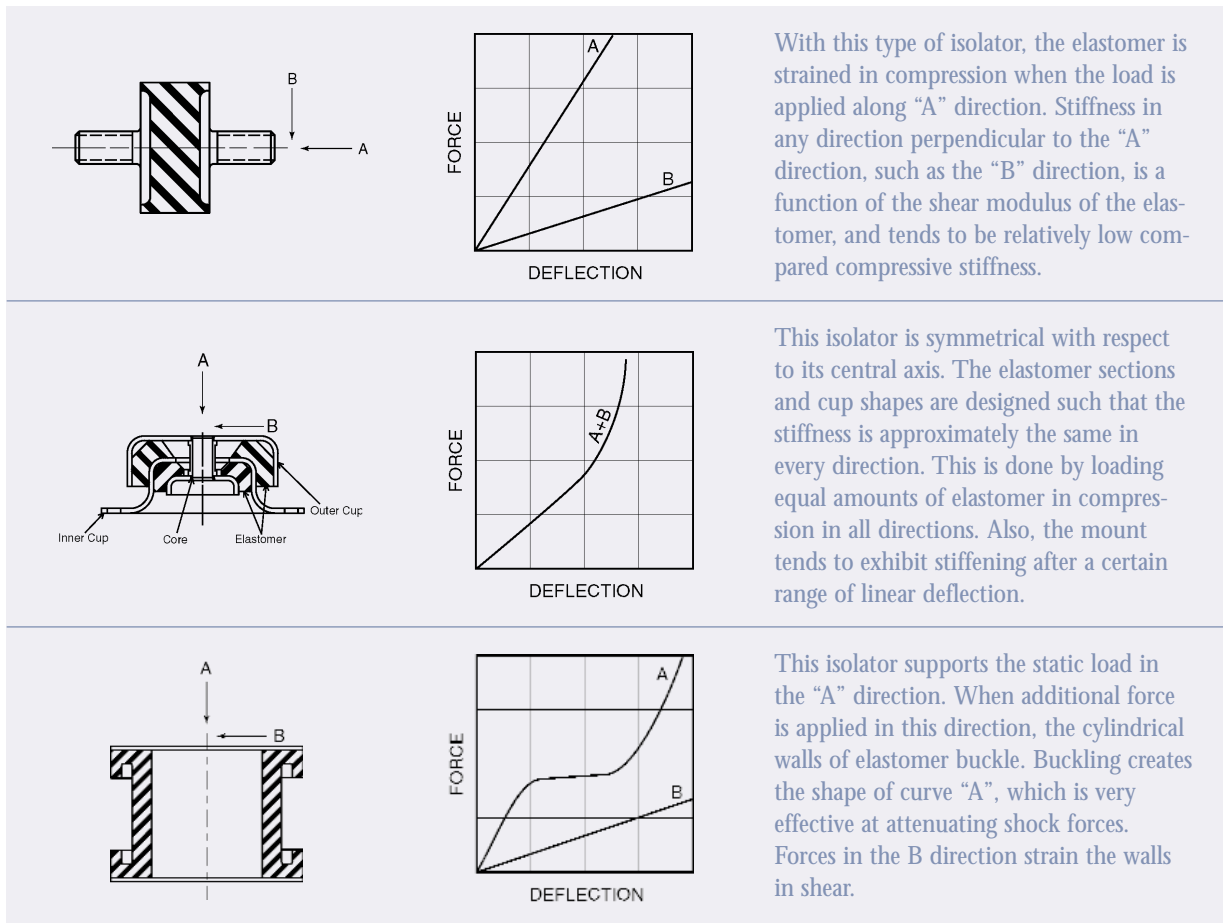

Figure 12 Force vs. Deflection curves for some typical elastomeric isolators

Elastomeric Isolators: Elastomers are well adapted for use in shock isolators because of their high energy storage capacity and because the convenience of molding to any shape makes it possible to attain the linearity or nonlinearity required for adequate shock isolation.

Most elastomeric isolators cannot be constantly subjected to large strains. An isolator with a large static deflection may give satisfactory performance temporarily but it tends to drift or creep excessively over a relatively short period of time. Opinions on maximum permissible static strain vary widely, but it may be taken as a conservative limitation that elastomers should not be continuously strained more than 10 to 15% in compression, nor more than 25 to 50% in shear. These rules of thumb are often used to determine the maximum load capacity of a given isolator.

In spite of the limitations of elastomeric materials used in isolators, the overall advantages far outweigh the disadvantages and make elastomers the most highly desirable type of resilient media for isolators.

With this type of isolator, the elastomer is strained in compression when the load is applied along “A” direction. Stiffness in any direction perpendicular to the “A” direction,

such as the “B” direction, is a function of the shear modulus of the elastomer, and tends to be relatively low compared compressive stiffness.

Springs: Metal springs can be used as vibration isolators. In some instances, these types of isolators work well. Frequently, the lack of damping in these type of isolators forces them to experience extremely violent resonances conditions (see “Damping” section and Figure 8).

Combination Spring-Friction Damper: To overcome the disadvantages of little or no damping in coil springs, friction dampers can be designed in parallel with the load-carrying spring. These types of isolators are widely used in practice. An example of this is illustrated in Figure 13.

In this construction, along the vertical axis a plastic damper slides along the walls of a cup housing, and the normal force is provided by a radial damper spring. For horizontal damping, a central metal core which is directly attached on its top side to the equipment bears on the damper on its bottom side. The normal force is provided by the weight of the equipment, and damping results from the sliding during horizontal excitations. Transmissibility values of about 2 are exhibited by using this type of spring/damper combination.

Properties	Natural Rubber	Neoprene	Hi-Damp® Silicone	Barry LT Compound
Adhesion to Metal	Excellent	Excellent	Good	Very Good
Tensile Strength	Excellent	Excellent	Good	Excellent
Tear Resistance	Good	Good	Fair	Good
Compression Set Resistance	Good	Fair	Fair	Good
Damping Factor, C/Cc (approx.)	0.05	0.05	0.15	0.12
Operating Temperature (max)	200F	200F	300F	200F
Stiffness Increase (approx.) @ -65F	10X	10X	< 2X	2X
Oil Resistance	Poor	Good	Fair	Fair
Ozone Resistance	Poor	Good	Excellent	Fair
Resistance to Sunlight Aging	Poor	Very Good	Excellent	Good
Resistance to Heat Aging	Fair	Good	Excellent	Good
Cost	Low	Low	High	Moderate

Table 2 Relative properties of elastomers used as the resilient media for isolators

Combination Springs with Air Damping:

Another method of adding damping to a spring is by use of an air chamber with an orifice for metering the air flow. An example of this type of isolator is illustrated in Figure 14. In this construction the load-carrying spring is located within the confines of an elastomeric damping balloon. The air chamber is formed by closing the balloon with a cap which contains an orifice or the force flow metering. Under dynamic excitations the air in the balloon passes through a predetermined sized orifice by which damping is closely controlled. Transmissibilities generally under 4 result with this type of design.

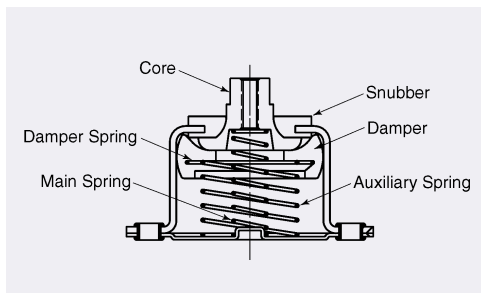

Figure 13 Isolator using friction damped spring.

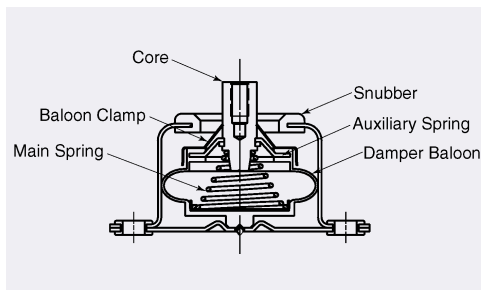

Figure 14 Isolator using air damped spring.

Air-damped springs have some specific advantages over seemingly similar friction damped designs with respect to isolating low-level inputs. Air damping, a form of viscous damping, causes the damping forces to be reduced if the input levels are reduced.

With friction damping, the friction force is constant. In practice, this means that the damping ratio is effectively increased with the input levels are decreased. Referring to Figure 8, one can see increasing the damping ratio decreases the level of isolation. In summary, air damped isolators are best suited for isolating low-level vibrations, while friction damped isolators are usually ideal for higher-level vibrations.

Combination Springs with Wire Mesh Damping:

For applications where all metal isolators are desired because of temperature extremes or other environmental factors, damping can be added to a load carrying spring by use of metal mesh inserts. Figure 15 illustrates this concept.

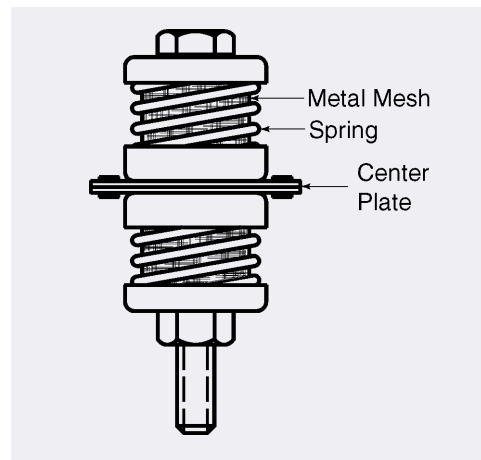

Figure 15 Isolator using metal-mesh damped spring.

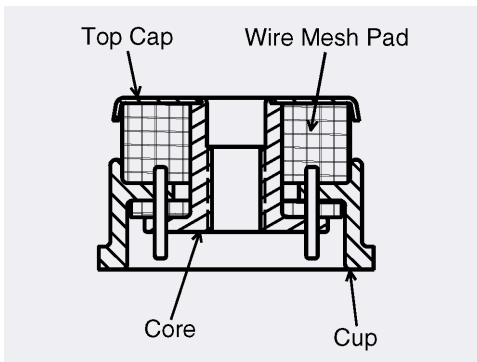

Figure 16 Isolator with wire mesh load carrying pad.

In this construction a knitted mesh wire is formed into a resilient cushion and inserted within the inside diameter of the coil spring. When dynamic loads are applied, the strands of the mesh rub on each other and damping is accomplished. Transmissibilities under 6 are generally exhibited by the spring-wire mesh damper combination.

Wire mesh cushions are sometimes used as isolators without the addition of a spring in parallel. Although transmissibilities of such an isolator range in the region of 4, an isolator so designed has the disadvantage of creep or high compression set. Once the metal pads take a compression set their performance under dynamic conditions is difficult to predict. An example of this type isolator is illustrated in Figure 16.

Pneumatic Systems: This type of isolator utilizes the principle of supporting the static load on an air column. It is particularly useful where low f_n systems are required; that is, 0.5 to 3 Hz region. An air spring enables the system to have a “zero” static deflection under load. This is particularly noteworthy since a conventional spring system would need to deflect a magnitude of 3.3 feet to acquire a 0.5 Hz natural frequency and 1.1 in. for a 3 Hz natural frequency. Pneumatic isolators can use a method of damping called sprung damping. This allows the isolator to have very high damping at resonance, but very low damping in the isolation region. A Barry pneumatic isolator which follows the laws of relaxation of sprung damping offers the benefits of very low T at resonance (generally 1.5) and yet offer a high degree of isolation in the high-frequency regions by acting as an undamped spring.

This catalog contains information on the SLM series of pneumatic isolators. Barry Controls also offers a complete line of actively controlled pneumatic isolators. To request a copy of our Active and Pneumatic Vibration Solutions brochure, call 1-800-BARRY MA.

Miscellaneous Types of Isolators: Other materials sometimes are used for vibration and shock isolators. Wool felt is often used for mounting entire machines but is seldom designed as a component part of a machine. A similar situa-

tion exists with regard to cork. Another material in the same category is neoprene impregnated fabric. The manufacturers of spun glass have also suggested the use of this material for the isolation of vibration. All of these materials appear to have characteristic advantages for particular installation. However, the ability of these materials to isolate vibration and particularly shock is difficult to predict, and the dynamic properties of these materials are not well documented in the technical literature.

Little difficulty is encountered in the design of isolators using elastomeric materials or metal springs. The performance characteristics of these materials are very predictable under dynamic conditions.

STEP-BY-STEP ISOLATOR SELECTION

Step 1: Determine the frequency of the disturbing vibration, often called the disturbing frequency, f_d . There are a number of ways to determine the disturbing frequency. For rotating equipment, the disturbing frequency is usually equal to the rotational speed of the equipment, expressed in revolutions per minute (RPM) or cycles per minute (CPM). If the speed is specified in RPM or CPM, it must be converted to cycles per second (Hz) by dividing by 60.

For other types of equipment, disturbing frequencies must be specified by the manufacturer or measured. Environmental vibrations can also be measured, or are sometimes specified in military or commercial specifications or test reports.

There could be more than one disturbing frequency. In this case, one should first focus on the lowest frequency. If the lowest frequency is isolated, then all of the other higher frequencies will also be isolated.

The most important thing to remember about vibration isolation is that without knowing the frequency of the disturbing vibration, no analytical isolation predictions can be made. In many of these cases, Barry Controls can recommend solutions that have worked well in similar past applications. Please contact our Applications Engineering Department at (800) BARRY-MA if you need help or advice on your application.

Step 2: Determine the minimum isolator natural frequency, f_n , that will provide isolation. This natural frequency can be calculated by using the following equation:

$$\text{Eq. 15} \quad f_n = \frac{f_d}{\sqrt{2}} \cong f_d \times .707$$

If this f_n is exceeded, this isolation system will not perform properly, and it is quite possible that you will amplify the vibrations. Isolators that have a f_n lower than that calculated in Equation 15 will provide isolation.

At this point, there will be many isolators that can be removed from the list of possible selections. Our catalog clearly states the natural frequency range of each isolator family in the main information block on the first page of each family. If any of the information is missing or unclear, please contact Barry Controls Applications Engineering at (800) BARRY-MA.

Step 3: Determine what isolator natural frequency will provide the desired level of isolation. Step 2 has provided a quick way to determine which mounts provide isolation, but does not provide any information on the level of isolation that will be achieved. Equation 11 can be used to calculate transmissibility:

(Eq. 11)
$$T = \left| \frac{1}{1 - \left(\frac{f_d}{f_n}\right)^2} \right|$$

Equation 11 can be used to calculate the transmissibility of a known disturbing frequency through a mount with a known natural frequency. It can also be rearranged to the following form:

Eq. 16
$$\text{when } \frac{f_d}{f_n} > 1, \quad f_n = \frac{f_d}{\sqrt{1 + \frac{1}{T}}}$$

Equation 16 is valid only when $f_d/f_n > 1$. This can be used to calculate the required natural frequency to achieve the desired level of isolation of a particular disturbing frequency.

Step 4: Select the appropriate isolator for your application. Step 3 should reduce the list of possible isolators considerably, but there still may be more than one isolator that “qualifies.” One way to determine which is best suited is to look under the “Applications” heading on the first page of each isolator family. If your application is not in this list, it does not necessarily mean that the isolator can’t be used, but there may be a better choice.

The selection can also be narrowed down by looking at the environmental and dimensional data sections for each candidate isolator. Is the temperature range appropriate? Can the isolator fit in the required space? Is the mount capable of supporting a load in the necessary direction? These are typical questions that can be used to make a final selection.

If there is still more than one isolator that fits your application, or if you cannot find one that meets all of your requirements, please contact our Applications Engineering department at (800) BARRY-MA. We have expert engineers available to help make selections and answer questions about our products. If you have trouble dialing our “800” number, please call our main switchboard at (617) 787-1555.

DESIGN EXAMPLES

This section deals with the selection and application of vibration and shock isolators. For the proper selections of isolators, it is desirable to obtain, where possible, pertinent information relating to the equipment, input and output requirements, and the general environment. Examples of the type of information or data required are:

Relating to the equipment:

- Weight.
- Dimensions.
- CG location.
- Number and location of isolators.
- Available space for isolators.
- Fragility level of the equipment.

Relating to the dynamic inputs and outputs:

- Level of vibration.
- Level of shock.
- Space limitations.

Relating to general environment:

- Temperature.
- Humidity.
- Salt spray.
- Corrosive atmosphere.
- Altitude.

All of the above information is not always readily available nor is it always completely required in some applications. This will be further clarified in the following problem examples.

Example 1 - Vertical Vibration: A metal tumbling drum directly driven by a 1080 RPM motor is causing vibration disturbance to the floor on which it is mounted the drum, motor, and support base weighs 400 pounds. There are 4 mounting points for the isolators. The required isolation is 80%.

1. Determine f_n of isolators required by using mathematical methods.
2. Determine static deflection of isolators by using (a) mathematical methods and (b) the static deflection vs. natural frequency curve in Figure 5.
3. Determine damping factor C/C_c to limit transmissibility at resonance to 10 by using (a) mathematical methods and (b) the transmissibility curve in Figure 8.
4. Determine the resilient media which could be used in the isolator selected to provide the C/C_c required.
5. Determine the proper isolator to use for this application.

Solution:

Known facts

$W = 400 \text{ lb}$

Weight per mounting point = $\frac{400}{4} = 100 \text{ lb}$

Isolation required = 80%
i.e. transmissibility = 0.20
Disturbing frequency, $f_d = 1080 \text{ RPM}$

- 1. Using Equation 16, page 63:

$$f_n = \frac{f_d}{\sqrt{1 + \frac{1}{T}}} = \frac{18}{\sqrt{1 + \frac{1}{.2}}} = 7.35 \text{ Hz}$$

- 2a. To find static deflection using mathematical approach use Equation 4, page 53:

$$\Delta_s = \frac{3.13^2}{f_n^2} = 0.18$$

- 2b. To find static deflection using static deflection-natural frequency curve Figure 5, page 56. The intersection of f_n of 7.35 Hz and the solid diagonal line yields a Δ_s of approximately 0.18 inches.

- 3a. To find C/C_c for a transmissibility of 10 by mathematical approach use Equation 12, page 54. Solving for C/C_c :

$$\frac{C}{C_c} = \frac{1}{2T} = 0.05$$

- 3b. To find C/C_c for a T of 10 by use of the transmissibility curve Figure 8, page 57. This curve shows that for a transmissibility of 10, $C/C_c = 0.05$.
- 4a. To find the correct resilient media which exhibits a $C/C_c = 0.05$ refer to Table 1, page 57. It can be seen that natural rubber or neoprene would be the proper selection.
- 5a. An isolator which best fits the above solved parameters is Barry Part No. 633A-100. Refer to the product information on pages 116-118 of this catalog to confirm that this product meets all of the above needs.

Example 2 - Vertical and Horizontal

Vibration: An electronic transmitter which weighs 100 pounds, and has a height of 15", a width of 20" and a length of 30" is to be mounted in a ground vehicle which imparts both vertical and horizontal vibratory inputs to the equipment. Since rough terrain is to be encountered a captive isolator is required. Four mounting points, one at each corner, are provided. It has been determined that the first critical frequency of the equipment is such that

an isolator with a 25 Hz vertical natural frequency would be satisfactory. Select an appropriate isolator and determine the approximate horizontal rocking modes in the direction of the short axis of the equipment which would be excited.

Solution:

- 1. For vertical natural frequency:

Load per isolator = $100/4 = 25 \text{ lb}$.

Referring to a Barry isolator series designed for the rigors of vehicular applications, the 5200 series is suitable. From the load rating table in the product information section (18-30 pounds capacity for vehicular applications) would handle the 25 pound load.

Using the load vs. natural frequency plots on page 192, the intersection of the 5220 curve for the 25 pounds load yields an f_n of 24 Hz.

- 2. For horizontal rocking modes: The dynamic stiffness ratio of horizontal to vertical = 0.6 for the 5200 series. Referring to Figure 10, page 58 and assuming that mass is homogeneous and isolators are at extreme corners, the following is found:

$$R = \frac{K_L}{K_V} = 0.6$$
$$\frac{H}{W} = \frac{15}{20} = 0.67$$

From the curves in Figure 10, page 58, the ratios of f_n/f_{VERT} for first mode M1 is 0.7 and for second mode, M2, is 1.7.

f_n , 1st mode = $24 \times 0.7 = 16.9 \text{ Hz}$
 f_n , 2nd mode = $24 \times 1.7 = 40.8 \text{ Hz}$

It is seen that this procedure lends a ready solution to determining the horizontal rocking modes based on the assumptions made. This solution is not exact but is generally satisfactory for practical purposes.

Example 3 - Shock: An electronic equipment is to be subjected to a 15G, 11 millisecond half-sine shock input. The equipment is mounted on a 10 Hz natural frequency isolation system. Determine maximum shock transmission and isolator deflection.

Solution:

- 1. From Figure 11, page 59, the equation for shock velocity change for a half-sine pulse is:

$$V = \frac{2gA_0t_0}{\pi}$$

where: $A_0=15G$
 $t_0=0.011 \text{ sec}$
 $g=386 \text{ in/sec}^2$

$$V = \frac{2 \times 386 \times 15 \times 0.011}{\pi} = 40.5 \text{ in/sec}$$

using Equation 13, page 55, the maximum shock transmission is:

$$G_T = \frac{V(f_n)}{61.4} = \frac{40.5 \times 10}{61.4} = 6.6 \text{ G's}$$

using equation 14, page 55, the isolator deflection required to attenuate this shock:

$$\Delta_D = \frac{V}{2\pi f_n} = \frac{40.5}{2\pi(10)} = .64$$

This example could also be done in the “reverse” direction. If one knew the desired output, 6.6 G's, one could calculate the required natural frequency, 10 Hz, to attenuate the input shock.

In either case, the deflection is calculated last, and used to determine 1) if the allowable sway space is sufficient to accommodate the required deflection, and 2) if the selected isolator has enough linear deflection capability to withstand the shock.

ISOLATOR PROPERTIES MATRIX

Product†	Page Number	Load Range (lbs)	Natural Frequency	All Attitude	1:1 Stiffness	Primary Application	Specialty
Cupmounts	X	0-1800	High	Yes	Yes	Vibration	Low-profile, rugged
S-Mounts	X	0.3-45	Low	No*	No	Vibration	Air-damped
L-Mounts	X	0.4-40	Low	No*	No	Vibration	Friction-damped
H-Mounts	X	0.3-40	Low	No*	No	Vibration	Friction-damped
T-Mounts	X	0-150	High	Yes	Yes	Vibration	Friction-damped
B-Mounts	X	0-40	Mid/High	Yes	Yes	Vibration	Low-profile, buckling
ME Series	X	0-10	Mid	No	No	Vib/Shock	Low-profile, buckling
TTA Mounts	X	0-15	Mid	No	Yes	Shock	Buckling
TTB Mounts	X	0-30	High	No	No	Shock	Buckling
HTTA Mounts	X	0-20	Mid	No	No	Shock	Buckling
VHC Mounts	X	0-145	Mid	No	No	Shock	Buckling
Cablemounts	X	0-1800	Low/Mid	Yes	No	Shock	High-Temperature
2K Mounts/Systems	X	1-6000	Low/Mid	No*	No	Vib/Shock	Two-stage isolation
GB530 Mounts	X	0-1322	Low	No	No	Vib/Shock	Buckling, high capacity
Barryflex (GBCO) Mounts	X	0-40	Mid	No	No	Shock	Buckling
Stabl-Levl (SLM)	X	0-19200	Low	No*	Yes	Vibration	Pneumatic mount
LM and LMS Leveling Mounts	X	0-13000	Mid	No*	No	Vib/Shock	Built-in Leveling
633A Series	X	0-260	Low/Mid	No	No	Vibration	
Industrial Machinery Mounts	X	0-4400	Low/Mid	No	No	Vibration	
30005 Series Neoprene Pads	X	0-50 (psi)	High	No*	No	Vibration	
6300/6550 Series	X	0-18	Mid/High	Yes	Yes	Vibration	Low-profile
E21/E22	X	0-10	High	Yes	Yes	Vibration	Low-profile grommet
5200 Series	X	0-50	High	Yes	No	Vibration	Low-profile grommet
6820 Series	X	0-80	Mid	Yes	No	Vibration	Low-profile
500 Series	X	0-2700	Mid	No	Yes	Vibration	Rugged
500SL Series	X	0-920	Mid	No	No	Vibration	Low stiffness ration
HR Series	X	0-420	Mid	No	No	Vibration	High stiffness ratio
22000 Series	X	0-4500	Mid	Yes	Yes	Vibration	Low-cost, rugged
Barry-Bond Mounts	X	0-2100	Mid/High	No	No	Vibration	Low-cost
Industrial Conical Mounts	X	0-1146	Mid	No	No	Vibration	Rugged
Cylindrical Stud-Mounts	X	0-260	Low/Mid	No	No	Vib/Shock	Very Low-cost
W Series Ring and Bushing	X	0-350	Mid	Yes	No	Vibration	
Ball Mounts	X	0-9	Mid	No	No	Vibration	Light loads, low-cost
ES Series Elastomer Springs	X	0-14794	-	No*	No	Shock	Motion control

Key:

Frequency

Low: 10 Hz and below

Mid: 10 Hz to 20 Hz

High: 20 Hz and above

All Attitude

“Yes” means isolators can carry static load in any direction.

* indicates base loading only.

1:1 Stiffness

Refers to axial-to-radial stiffness ratio.

Primary Application

This indicates the type of environment that this mount was primarily designed for. In most cases, each series can be compatible with both shock and vibration environments.

†This matrix includes all general-purpose isolators in this catalog. There may also be specialty isolators that were designed specifically for your application. Please refer to the “Specialty Isolators” Section on page X of this catalog.