

# **New facility for large-scale DCG transmission holographic gratings : status and evaluation**

S. Habraken, P. Lemaire, P.-A. Blanche, and C. Jamar  
Centre Spatial de Liège, Av. du Pré-Aily, B-4031 Angleur (Belgium)

## **ABSTRACT**

The recent interest of the astronomer community for volume phase holographic gratings is directly related to the enhancement of spectrograph throughput since the grating can rise higher diffraction efficiency. Indeed, dichromated gelatin technology has demonstrated capability for 70-90% efficiency.

From the heritage of several diffractive and holographic projects and applications, the Centre Spatial de Liege has recently decided to invest in the large-scale DCG grating technology.

This paper will present the new facility presently under construction. The goal is to be ready to respond to the market demand in 2002 with a capacity for producing 30 cm dia. holographic gratings. The challenge is not the size itself but the quality control in each process step. Thanks to the heritage of space instrumentation, CSL is trained to fulfill requirements on product and quality control.

Large clean rooms are equipped with DCG coating machine, optical bench, development lab, and conditioning processes. The grating period may range from 325 to 3000 lp/mm. Low frequencies are especially hard to holographically record because it induces a cumbersome set-up.

The working wavelength of DCG gratings is limited by the gelatin transmissivity (from 350 nm to 2  $\mu$ m). But the actual limitation factor in the IR is the refractive index modulation, equivalent to etching depth on ruled gratings: working wavelength of 1.5  $\mu$ m means a need for 3 times the modulation of a "visible" grating. Large efforts are needed to insure that IR volume-phase gratings can reach efficiency higher than alternative grating technologies. In that field, this paper presents experimental results on small grating samples. A realistic performance goal is discussed to advise the astronomer community of our near-future products.

**Keywords:** dichromated gelatin, spectrograph, grating, holography.

## **1. INTRODUCTION**

### **CSL technical background**

CSL and the University of Liege have been involved in R&D program in holography since 20 years. Interferometry, recording materials, and optical elements have been extensively studied. Dichromated Gelatin (DCG) is worldwide recognized as the holographic material with the highest diffraction efficiency thanks to its capability to record the highest refractive index modulation. The authors started to investigate that material in 1990 [1] in the field of holographic optical elements. Very efficient reflection and transmission holographic gratings were recorded [2].

Works are also conducted in the field of surface-relief gratings by recording on a photoresist material [3]. Polarizer gratings [2-4] and master gratings for embossed holography are realized in small size.

The theoretical background of CSL in the field of diffraction gratings was related to polarization analysis in diffraction gratings. The theory from R. Petit and al. [5] is the most powerful base for computation of surface-relief gratings. In the field of volume gratings, the Kogelnik [6] theory of coupled-waves is still the most popular one. However, since the eighties, new grating properties were highlighted and required the use of vectorial theory instead of scalar theory. M.G. Moharam and T.K. Gaylord [7] were very successful in defining a rigorous vectorial extension of the well-known Kogelnik coupled-wave theory.

Nowadays, commercial softwares are available for analyzing volume gratings (i.e. G-Solver®). However, several labs preferred to write their own code based on the Rigorous Coupled-Wave Theory (RCWT) including recent numerical improvements [8] and the extension to surface-relief gratings [9]. This is the case of CSL and the University of Liege which are using the RCWT code since '94. This powerful tool is very flexible to study specific gratings.

This background experience of CSL was estimated as a realistic starting point for a commercial activity in diffraction gratings. Our major threshold toward the market of Volume Phase Holographic Gratings (VPHG) was certainly the size and the quality criterion that is required.

## Astronomer interest for VPH gratings

Since a few years, astronomers found several interests in using VPH gratings instead of ruled (surface-relief) gratings [10]. One of the major advantage is the capability to reach higher diffraction efficiency with very low noise. The relative easiness of manufacturing, compared to ruling, and the flexibility for changing the line frequency are very attractive. Of course, recording several 100,000 lines on a substrate by a quick laser shoot seems much easier and faster than diamond-ruling each lines one by one !

The main drawback of VPH gratings is certainly related to its angular and spectral selectivities, compared to ruled metallized gratings. The useful wavelength range is relatively shorter when the grating is depicting low index modulation. For that reason, the present technology requires the highest index modulation to be recorded on a DCG layer with optimized thickness to verify the maximum efficiency at the central wavelength of operation.

Based on those basic considerations, KOSI [11] and RALCON [12] were the first to manufacture VPH gratings for astronomers. Some gratings are now successfully operating. Their size is limited to ~10 cm with further size extent to be expected.

Actually, the holographic recording of plane gratings requires a set-up with two interfering collimated laser beams. The realization of large collimated beams with high optical quality is challenging and expensive.

In order to reply to the request of astronomers, CSL has investigated ways to find the funding for large-scale VPH gratings. The minimum size of the present requirement is ~20 cm dia. It is foreseen that, if this technology emerges, there will be a demand for larger scale gratings. For that reason, CSL decided to investigate the production of, at least, 30 cm dia. VPH gratings. Thanks to the Walloon Government and to the EGUNA Consortium [13], the activity started in November 2000. The EGUNA Consortium is directed by the European Southern Observatory (ESO). It is composed of several world leading astronomic Institutes.

## Project Flowchart

The flowchart below summarizes the interaction that made possible this R&D phase and, later, the commercial start-up.

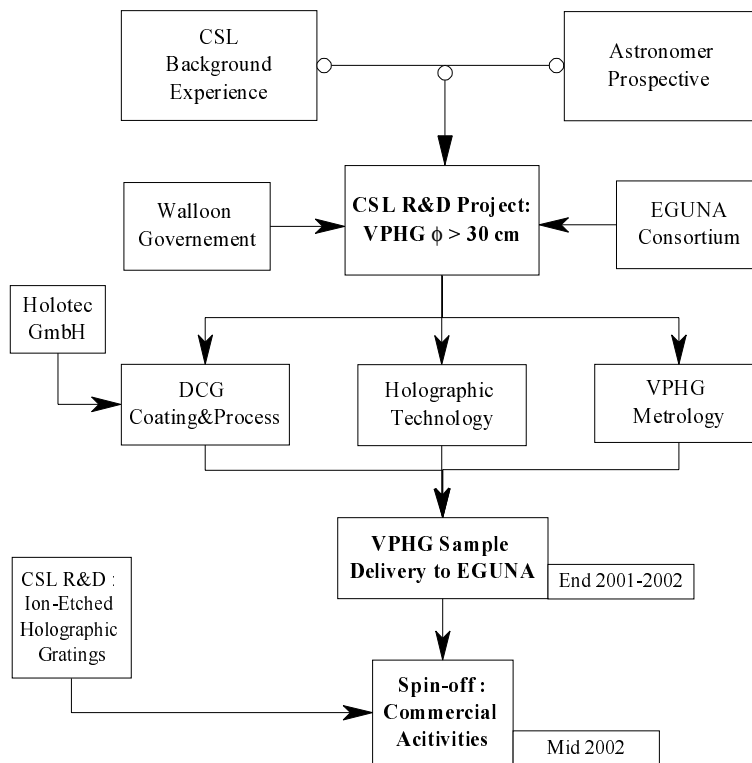

Table 1 : Flowchart showing the CSL R&D phase to be transferred to a spin-off Company.

The participation of Holotec GmbH [14] was a good opportunity to work with a worldwide specialist in DCG and large-scale film coating. The coating machine is designed and manufactured by Holotec. The DCG process (coating and development) is deduced from Holotec procedure under licensing fees.

The R&D activity on reactive ion etching is another good opportunity to match the technology under synergy. Indeed, the etching is used to transfer a pattern from a photoresist material into the substrate. In the specific case of diffraction gratings, a surface-relief holographic grating is recorded on photoresist. After development, the diffraction pattern will be transferred to glass substrate. Groove profile can be tailored during the etching process to fit with the efficiency and selectivity criteria. The final grating is monolithic which is especially useful under space environment (cryogenic temperature and cycles, for instance). The holographic set-up for large-scale VPHG is perfectly fitting with the holographic requirements of photoresist gratings too.

## 2. HOLOGRAPHIC FACILITY AND RELATED SET-UP

Facilities have been scaled to accommodate blanks up to 40 cm x 40 cm. The dichromated gelatin coating machine can hold 50 cm x 50 cm flat glass. Optical quality is obtained on 40 cm x 40 cm. Gelatin layers up to 25  $\mu\text{m}$  when dried can be coated with high uniformity (local deviation lower than 1  $\mu\text{m}$  PV).

Recording is performed on a 1.5 m x 5 m optical bench. The laser source is an argon laser Innova Sabre TSM 25 from Coherent, which can deliver 4.8 watts at 488 nm. The set-up geometry is shown in Figure 1 and Figure 2. The argon laser beam comes up from a hole drilled into the table center. It is splitted in two beams having the same intensity and polarization. They are then filtered with pinholes holding out high energy. To ensure homogeneous illumination in the sample area, beams are broadened nearly twice the useful diameter. Two off-axis parabolic mirrors polished by Optical Surfaces™ collimate the useful beams. Their clear aperture diameter is 38 cm with a focal length of 200 cm. To adjust illumination angle, two flat mirrors with 38 cm clear aperture diameter fold the beams. Thus, the fringe frequency can be changed continuously from 315 lp/mm (Figure 2a) up to 3000 lp/mm (1500 lp/mm shown in Figure 2b). Higher frequency could, of course, be recorded in DCG layer. The recording set-up should include large-scale prisms for increasing the beam angle inside optical media.

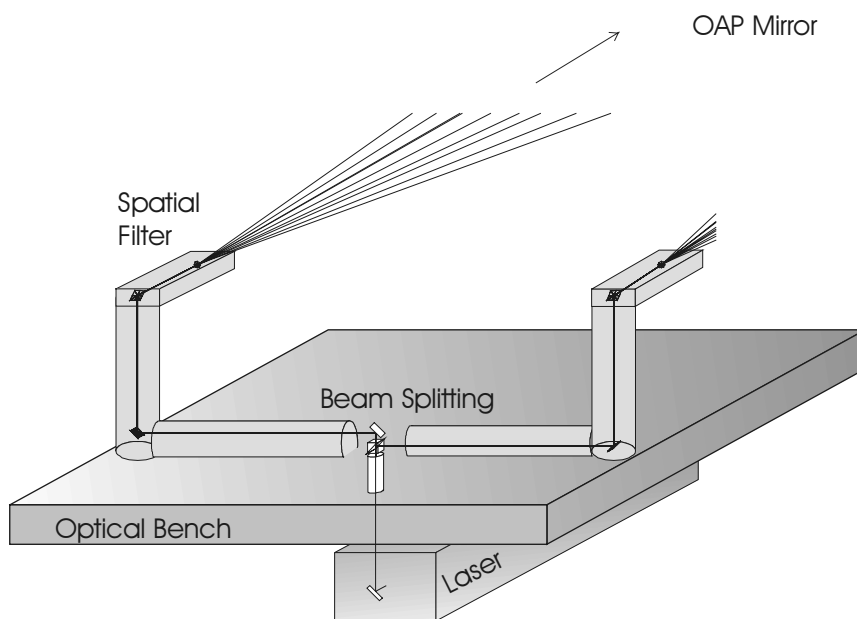
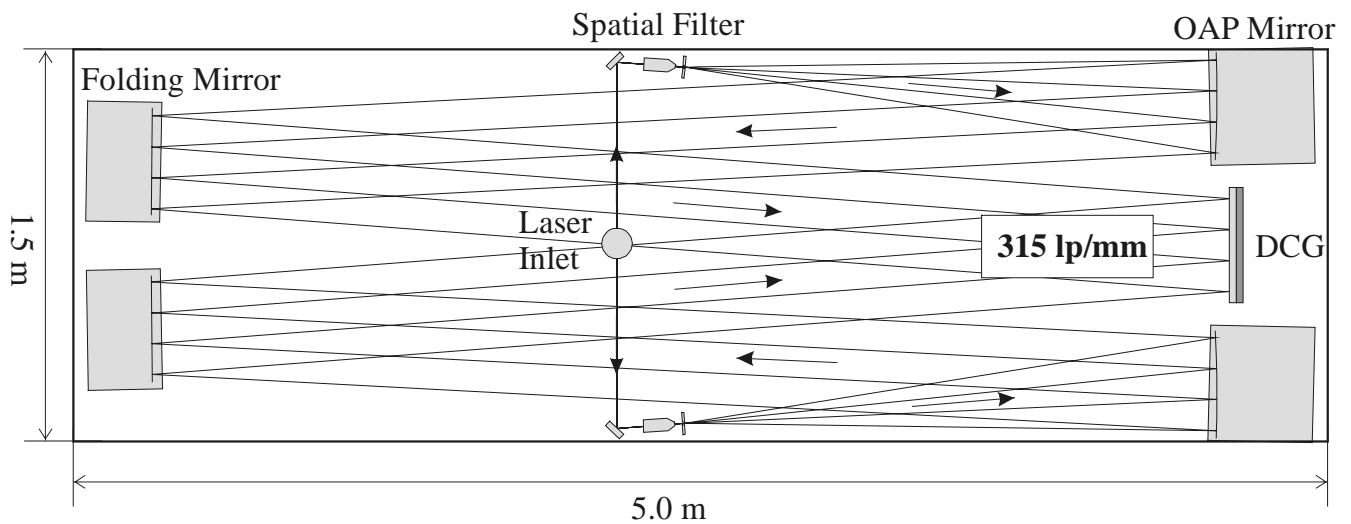
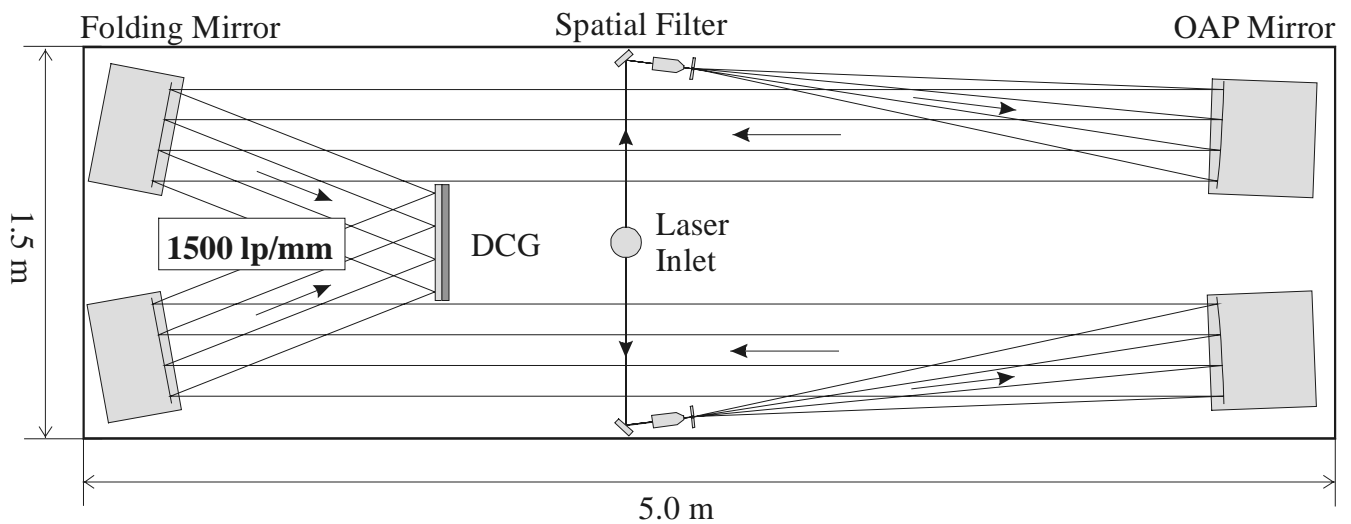

Figure 1: Holographic recording set-up geometry. Perspective view.



(a)



(b)

**Figure 2: Holographic recording set-up geometry. Top view. (a) 315 lp/mm, (b) 1500 lp/mm**

Due to edges diffraction, we expect to keep the requested optical quality for recording beams up to 32 cm diameter.

The development laboratory is set up with six thermostated baths. Inner baths are 53 x 65 cm<sup>2</sup>. Forced convection oven with interior dimensions 80 x 60 x 50 cm<sup>3</sup> dries the developed holograms.

These three laboratories, i.e. coating, exposure and development, are equipped with air conditioning which regulates temperature and hygrometry. Moreover, laminar fluxes maintain laboratories as clean rooms of class 100, following the technical heritage of CSL in space optical payload qualification. Lightning is filtered with Deep Orange Lee filters which efficiently reject the spectral bandwidth of DCG photosensitivity.

### 3. METROLOGY AND CERTIFICATION

Our goal is to control each process steps to produce very high quality holograms. Therefore, metrology and certification take an important part of our effort.

Diffraction efficiency and diffracted phase will be monitored over the full hologram surface by the way of an interferometer. The later will be installed directly after one of the spatial filter as shown in Figure 3a. The diffracted beam will be retro-reflected by a flat mirror placed behind the hologram. Thus, we are exactly in the same conditions as during the recording. The interferometer shown in Figure 3b is constituted by a 50/50 beam splitter cube which sends one part of the beam to the sample, the other to a phase shifting piezoelectric mechanism. After reflection, beams are recombined by the cube and a CCD camera records the phase image projected to a rotating disc. To correct the phase from distortion introduced by the whole system, we will subtract the phase recorded without any sample.

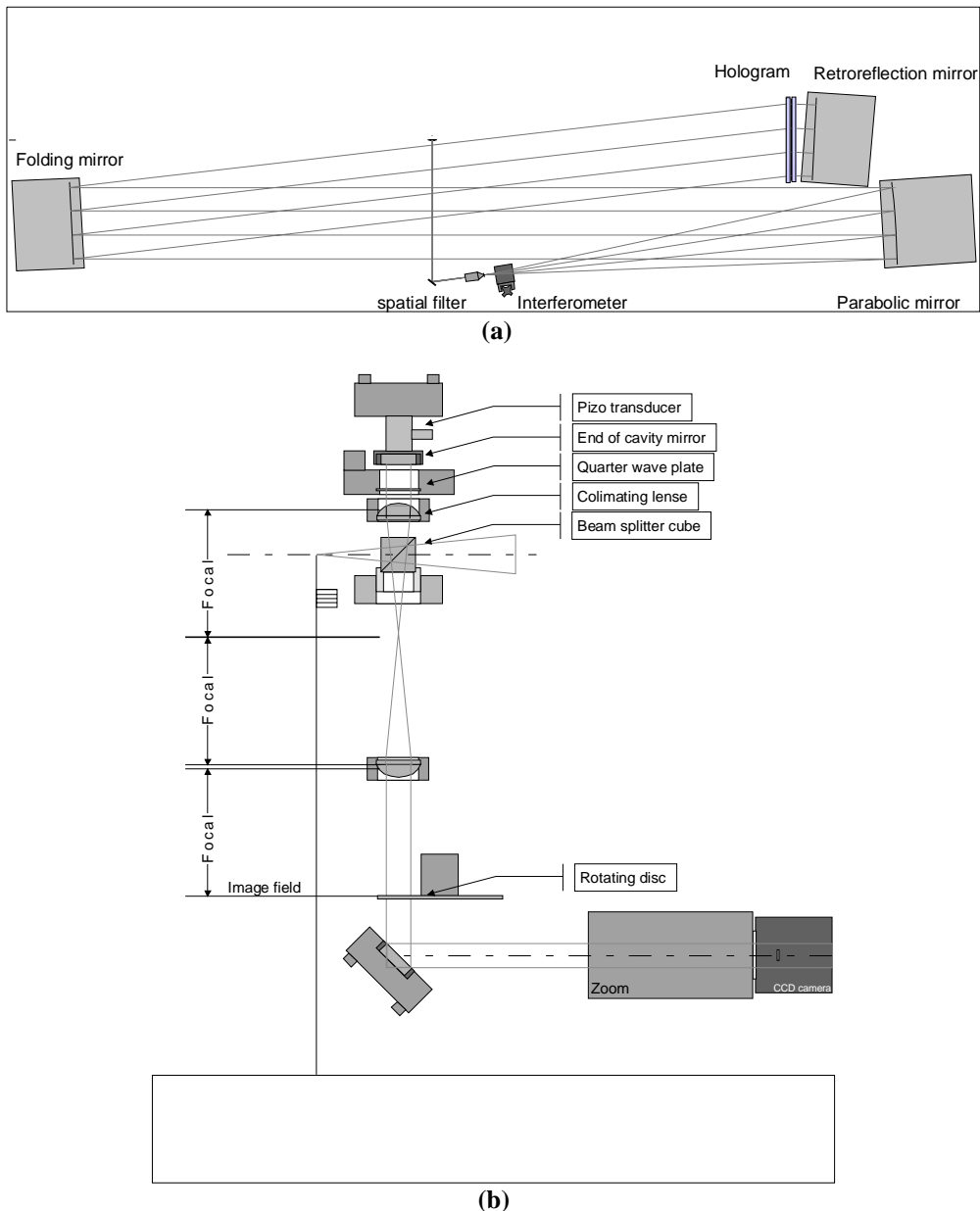

Figure 3: Interferometer set-up. (a) Top view on the optical bench, (b) lateral view of the interferometer main body.

The diffraction efficiency map will be measured by blocking the beam going to the phase shifting system. Thus, we record an image diffracted back and forth by the hologram.

Blaze and superblaze will be measured in several positions by an optical fiber spectrometer (wavelength range: 200-1100 nm). The most representative positions can be chosen thanks to the information coming from the diffraction efficiency map.

With the use of the RCWT code, experimental data permit to interpolate blaze as well as superblaze grating characteristics. The hologram index modulation and mean refractive index are accessible. Likewise, this software will allow us to extrapolate spectral behavior such as the blaze and superblaze profile at wavelengths out of the spectrometer range.

#### 4. GRATING SAMPLES

Currently, coating and exposition laboratories are not completely furnished and can not be used (see next section: schedule). However, we have a smaller exposition set-up and an operational development laboratory. Pre-coated samples of dichromated gelatin have been bought to the coating machine supplier in order to begin optimization of the exposition, development and encapsulation procedures. Of course, we can not modify important parameters such as gelatin thickness, ammonium dichromate concentration and pre-hardening. Still, a lot can be done on other parameters like exposition energy, development bath temperature, fixer brand and kind, ...

Figure 4 present the diffraction efficiency versus the writing energy density. These are rough data : interface reflections are not removed. For these holograms, the wavelength was 514.5 nm for both recording and diffraction measurement, line frequency is around 1000 lp/mm and gelatin layer thickness is about 13  $\mu\text{m}$ . Best results are obtained for recording energy density between 200 and 300  $\text{mJ}/\text{cm}^2$ . External diffraction efficiency can rise up to 83%. In these cases, it was experimentally measured that less than 1% of the incident light is transmitted in the zero order (for TE Polarization).

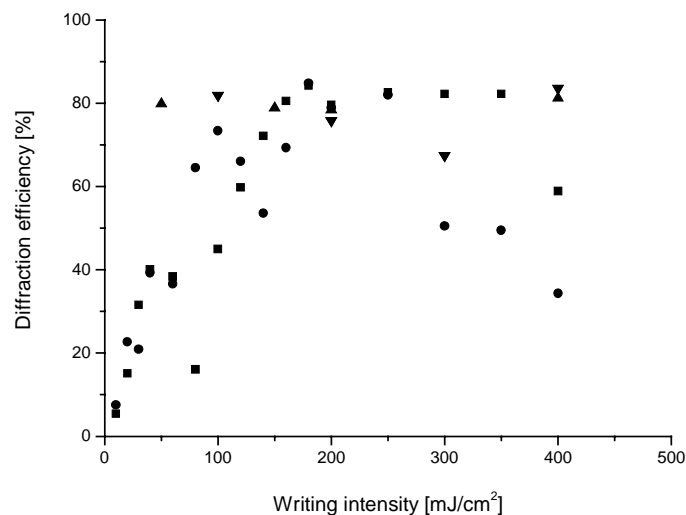

**Figure 4: Typical sensitivity curve showing the diffraction efficiency versus recording energy density (TE polarization).**

We have investigated the development procedure. Our goal is to increase the index modulation as high as possible. Our first results show a modulation increase from 0.02 to 0.03, mainly by changing the development bath temperature. We expect to reach 0.04 by reducing the gelatin thickness and by pre-hardening. A lot of ways are still to be explored since DCG photochemistry is very complex with the advantage of offering several degrees of freedom.

Figure 5 shows the influence of the developing bath temperature. We can shift the maximum diffraction efficiency from green wavelength (514.5 nm) to the red (633 nm) or even further (with TE polarization). This reflects a significant increase of the index modulation. The data depicted in figure 5 were compiled after rejection of gratings with noise increase and diffracted wavefront non-uniformity. The cosmetic aspect of such rejected gratings is often characterized by a milky gelatin aspect but they reach very high index modulation.

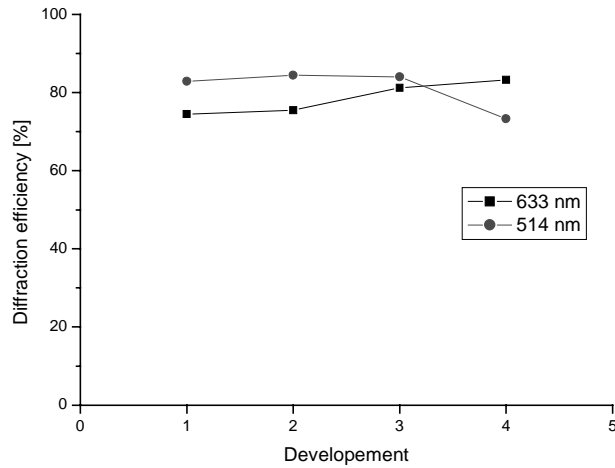

**Figure 5: Diffraction efficiency at 514.5 and 633 nm versus developing procedure (TE polarization).**

In order to introduce the right parameter into the diffraction mathematical simulations, we have measured the gelatin thickness under several conditions with a Wyko optical profilometer (Figure 6). The undeveloped gelatin layer is 10.7  $\mu\text{m}$  thick. As it is well known, gelatin swells during development and we have measured 13.5  $\mu\text{m}$  in unexposed regions. But, as shown in Figure 6b, the gelatin layer collapses by around 300 nm when exposed to actinide light. The fringes in Figure 6c are due to diffraction by the mask edges.

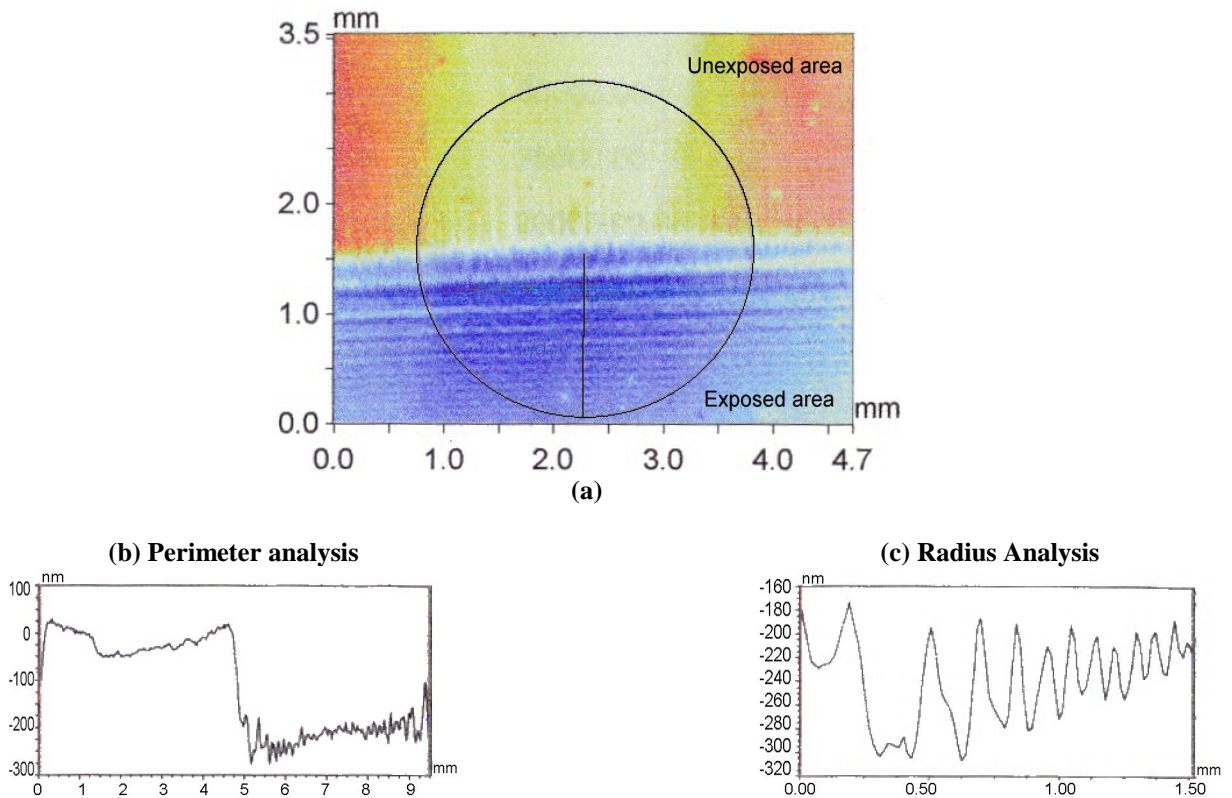

**Figure 6: Gelatin thickness measurement. (a) map view, (b) perimeter analysis of the drawn circle, (c) radius analysis of the drawn circle. The reference thickness (y-ordinate origin) is 13.5  $\mu\text{m}$ .**

## 5. SCHEDULE AND COMMERCIAL START-UP

In September 2001, the hardware delivery should be accomplished. Large-scale grating production will begin.

Major steps of the scaling up will be:

- DCG coating up to 50 cm x 50 cm (with 40 cm x 40 cm uniformity)
- Optical set-up including optical bench, 38 cm dia. mirrors and Ar Laser
- Development lab with large thermostatic baths
- Air conditioning in every labs.
- High cleanliness in restricted areas (Class 100).
- Metrology by interferometry and spectrometry.

The scaling-up is expected to require an optimization phase.

In parallel, CSL will continue to enhance the DCG process in regard to the index modulation, the diffraction efficiency uniformity, the noise level, and the protective sealing on small samples.

The progress should allow us to start the recording of large VPH gratings for the EGUNA Consortium before the end of 2001. CSL is engaged to produce and deliver 10 gratings by the end of April 2002.

The project success and the astronomer further interest will jointly decide us to generate a spin-off company for mid 2002. The main product of that spin-off will be large-scale VPH gratings but further applications are expected (holographic optical elements, ion-etched surface-relief gratings,...).

## 6. CONCLUSIONS

This paper summarized the beginning of promising activities in the field of Volume Phase Holographic Gratings for the Astronomer Community. The hardware delivery phase is almost accomplished. For that reason, scaling up to the recording of large-scale gratings is the (very) near-future phase.

Major steps to achieve a high quality level in grating manufacturing are under optimization. Until now, no major problems are encountered. The schedule is very tight but no slipping is presently foreseen.

With the demonstration of grating size in the range of 30 cm dia., CSL expects to quickly generate a commercial interest :

- The demand is growing only when the manufacturing is proven.
- Unfortunately, until now, the manufacturing capability did not exist because the demand was not demonstrated !

After the present R&D phase, the technological knowledge will be transferred to a new commercial company with core business in the field of holographic optical elements, including gratings.

## 7. ACKNOWLEDGEMENTS

This work is supported by the Walloon Government under the contract RW n°14559.

The authors are also acknowledging the Astronomer Consortium 'EGUNA', directed by the European Southern Observatory for their technical guidance and financial support.

## 8. REFERENCES

1. S. Habraken and St. Roose, "Comparison of copy-methods of computer-generated holograms in dichromated gelatin : application to holographic optical element, " HOLO 3 meeting, St Louis France (1991).
2. S. Habraken, Y. Renotte, St. Roose, E. Stijns, and Y. Lion, "Design of polarizing holographic optical elements, " Applied Optics **34**, 3595-3602 (1995).
3. S. Habraken, O. Michaux, Y. Renotte, and Y. Lion, "Polarizing holographic beam splitter on photoresist, "Optics Letters **20**(22), 2348-2350 (1995).
4. S. Habraken, Y. Renotte, E. Stijns, and Y. Lion, "Polarizing Holographic Optical Elements in Du Pont's Omnidex™ films, " Proc. SPIE **2532**, 141-147 (1995).
5. R. Petit, *Topics in Current Physics : Electromagnetic Theory of Gratings* Vol. **22** Ed. R. Petit, Springer-Verlag Berlin (1980).
6. H. Kogelnik, "Coupled-Wave Theory of Thick Hologram Gratings, " Bell Syst. Techn. J., **48**, 2909 (1969).
7. T.K. Gaylord and M.G. Moharam, "Three-dimensional Vector Coupled-wave Analysis of Planar-grating Diffraction, " J. Opt. Soc. Am., **73**(9), 1105 (1983).
8. P. Lalanne and G.M. Morris, "Highly improved convergence of the coupled-wave method for TM polarization, " J. Opt. Soc. Am. A, **13**, 779-782 (1996).
9. T.K. Gaylord and M.G. Moharam, "Rigorous Coupled-wave Analysis of Metallic Surface-relief gratings, " J. Opt. Soc. Am. A, **3**(11), 1780 (1986).
10. National Optical Astronomy Observatories web site : <http://www.noao.edu/ets/vpgratings/>
11. Kaiser Optical Systems Inc. web site: <http://www.kosi.com/raman/applications/technotes/hsg.html>
12. Ralcon Development Lab web site: <http://www.xmission.com/~ralcon/>
13. EGUNA web site: <http://golem.merate.mi.astro.it/projects/vph/csl/>
14. Holotec web site : <http://www.holotec.de/index.htm>